

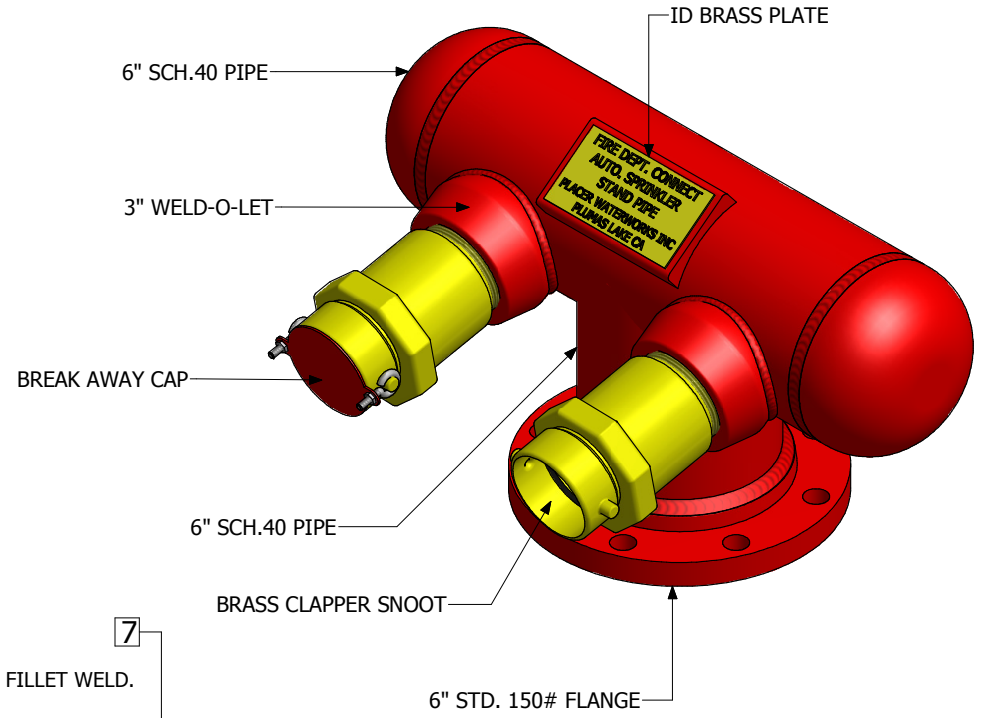

1325 Furneaux Road, Plumas Lakes, CA. 95961
(530) 742-9675
www.placerwaterworks.com

6" (2 PORTS) FIRE DEPARTMENT CONNECTION PW/FDC-213H

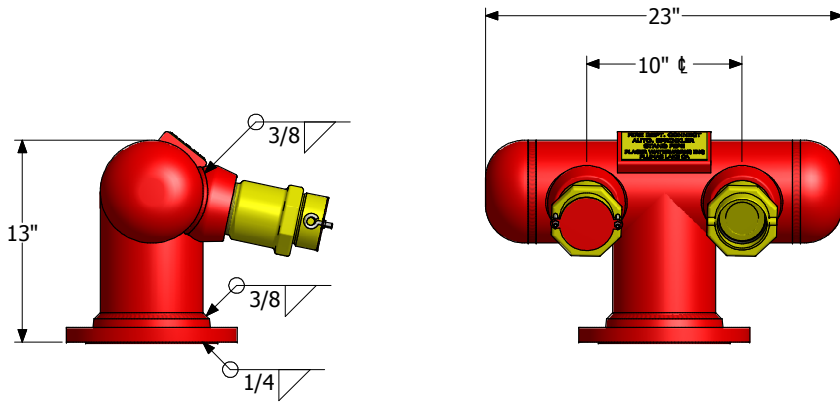

NOTES:

1. ALL HORIZONTAL & VERTICAL PIPE IS 6" A-53, SCHEDULE 40 BLACK TYPE.
2. 3" WELD-O-LETS WELDED ON 10" CENTERS WITH FIRST - A ROOT PASS. SECOND, FILLET PASS. FINISH WITH A 3/8" FINAL PASS.
3. PIPE CAPS AND PIPE TO PIPE CONNECTION TO BE 100% PENETRATION.
4. WELDING TYPE: SEMI-AUTOMATIC NR 211 INNER SHIELD WIRE PER SECTION 9 ASME CODE.
5. 150# SLIP ON RAISED FACE FLANGE WELDED INSIDE W/ 1/4" FILLET AND EXTERIOR TO HAVE 3/8" FILLET WELD.
6. 3" WELD-O-LETS PLACE AT 12° DOWNWARDS POSITION TO ASSIST HOOK-UP PERFORMANCE TO THE BRASS CLAPPERS WITH 2-1/2" FEMALE SWIVEL CONNECTION.
7. ABOVE UL INFORMATION IS FOR "BRASS CLAPPER SNOOTS" ONLY
8. BRASS CLAPPER SNOOT'S TO HAVE BRASS PLATED FINISH
9. ENTIRE FIXTURE IS ABRASIVE BLASTED SSPC SP-5 WHITE METAL BLAST 2-3 MIL ANGULAR PROFILE THEN POWDER COATED RED W/ 4-6 MILS FILM THICKNESS.
10. ALL WELDING IS DONE PER AWS D1.1 SECTION 3 FCAW PROCESS.
11. NOT RECOMMENDED FOR WET SYSTEM.

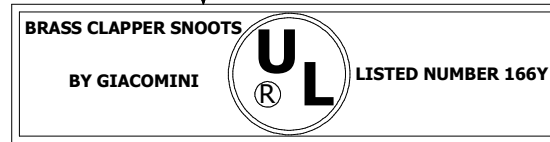

CAT#: PW/ FDC-213H: 6" (2 Ports) Fire Department Connection

Copyrighted 2014 Placer Waterworks, Inc. © All Right Reserved - For Duplication Authorization may obtain thru: kkern@placerwaterworks.com

*** CB: K.K 10/28/2014 REV. 00